

# Harmonic Mitigation by Optimal Allocation of Tuned Passive Filter in Distribution System

Adel Abou El-Ela<sup>1</sup>, Sohir M. Allam<sup>1</sup>, Asmaa A. Mubarak<sup>2</sup>, Ragab A. El-Sehiemy<sup>3</sup>

<sup>1</sup>Electrical Engineering Department, Faculty of Engineering, Menoufiya University, Shibin El Kom, Egypt

<sup>2</sup>South Delta Electricity Distribution Company, Menoufiya, Egypt

<sup>3</sup>Electrical Engineering Department, Faculty of Engineering, Kafr El Sheikh University, Kafr El Sheikh, Egypt

Email: adel.aboalella@sh-eng.menofia.edu.eg, sohirallam@yahoo.com, eng.asmaa.mubarak@gmail.com

**How to cite this paper:** El-Ela, A.A., Allam, S.M., Mubarak, A.A. and El-Sehiemy, R.A. (2022) Harmonic Mitigation by Optimal Allocation of Tuned Passive Filter in Distribution System. *Energy and Power Engineering*, 14, 291-312.

<https://doi.org/10.4236/epe.2022.147016>

**Received:** May 17, 2022

**Accepted:** July 26, 2022

**Published:** July 29, 2022

Copyright © 2022 by author(s) and Scientific Research Publishing Inc. This work is licensed under the Creative Commons Attribution International License (CC BY 4.0).

<http://creativecommons.org/licenses/by/4.0/>



Open Access

## Abstract

The purpose of this work is to determine the appropriate allocation of a single tuned passive filter “STPF” in a real distribution network at Tala city to prevent harmonic distortion caused by nonlinear loads. This design will cover the ideal filter parameter as well as the best filter position. The filter design is based on single and multi-objective functions that optimize the cost of the proposed filters, real power losses, total harmonic distortion “THD,” and individual harmonic distortion “IHD”. Upper and lower limitations for filter parameters, quality factor, voltage and harmonic distortion limits are determined using inequality constraints. This will be done under the equality constraint of power balance. The challenge of optimization is solved using two modern algorithms, jellyfish optimization technique “JFOT” and arithmetic optimization algorithm “AOA”, in which the placements of the filters and their parameters are selected. IEEE 33-bus radial system and an actual system as a part of the Egyptian network at Tala city are used for demonstrating the results obtained by the proposed techniques. The results reveal that the system’s harmonic distortion of current and voltage is reduced less than the limitations of the IEEE 519 standards.

## Keywords

Power Quality, Passive Filters, Harmonic Distortion, Filter Parameters, JFOT, AOA

## 1. Introduction

Power quality has now become a recurring issue as a result of the increased integration of renewable energy into the power system. With the injected harmonics from sources of renewable energy and unusual operating circumstances, some of

the results produced power is wasted as a result of harmonic injections of various constituents at each level of a system [1]. Systems for distribution harmonics are produced as a result of the existence of harmonic generating organisms. Equipment that causes overheating and malfunction of the gadgets; they are unfavorable because they result in power losses and have an impact on the voltage profile [2]. The electric current drop occurs in distribution feeders as a result of fluctuations in load demand, and it happens often falls within the operationally viable limitations inequitable [3]. As a result, voltage and current waveforms in a distribution or transmission system are rarely pure sinusoidal; rather, they contain a mixture of fundamentals, harmonics, and other frequencies generated by transients [4]. Loads having a nonlinear current-voltage characteristic introduce a wide variety of harmonics into the network, causing power quality to deteriorate [5]. When existing harmonics surpass of the IEEE 519 standard, they can produce a variety of difficulties, including power losses, resonance effects, communications conflicts, electric machine malfunction, and a decrease in equipment lifespan [6]. As a result, harmonic mitigation is critical for improving power quality [7]. If harmonics and the impacts of abnormal operating parameters could be eliminated, it would be less expensive and save time [8]. The distribution system must be improved in order to function correctly [9]. Low pass filters can solve that problem using a suitable optimization technique [10]. This equipment is joined in shunt with the network and consists of inductances (L), capacitors (C), and resistors (R) connected in series with each other to operate as a low impedance element, forcing the current at the tuned frequency to be absorbed by the filters and discharged to the ground [11].

The placement and design of these filters are crucial not just for improving power quality but also for reducing noise, while total generating costs are minimized. Some Algorithmic solutions have been shown to be successful in solving such optimization issues.

In [12], a new method for studying passive filter planning using simultaneous perturbation stochastic approximation was presented. In [13], the results of harmonic analysis and harmonic filter design for a grid-connected aluminum smelting plant. A method based on a genetic algorithm was shown in [14] to obtain the optimal size and location for single-tuned passive harmonic filters. In [15], numerical applications for the optimal allocation of passive filters in distribution electrical networks with static converters were presented. An immune-based adaptive dynamic clone selection algorithm was used in [16] to optimize the locations and sizes of filters in a distribution system with multiple buses and multiple feeders. In [17], an optimal capacitor placement using a hybrid honey bee colony optimization algorithm aiming to minimize power system losses and unbalances and maximize the ensuing net saving was presented while maintaining voltage and total harmonic distortion of buses in an acceptable range according to IEEE standards. In [18], a genetic algorithm for simultaneous power quality improvement, optimal placement and sizing of fixed capacitor banks in radial dis-

tribution networks was presented with nonlinear loads and distributed generation imposing voltage-current harmonics. In [19], a procedure based on fuzzy logic and the immune algorithm for the placement and sizing of shunt capacitor banks in a distorted power network was presented. In [20], particle swarm optimization integrated with a harmonic power flow algorithm for optimal capacitor placement and sizing in unbalanced distribution systems was presented. In [21], a fuzzy-based algorithm for the placement and sizing of shunt capacitor banks in a harmonics-polluted distribution system was presented.

All the previews mentioned papers help in studding the passive filter and all algorithms used in them help in determining the optimal algorithm that can be used to calculate the optimal passive filter parameters and its optimal location.

The focus of this paper is on lowering overall power loss and reducing the impact of total harmonic distortion generated by harmonics in utilizing JFOT and AOA to optimize the placement and size of the low pass harmonic filter in a real network at Tala city. The designed filter will achieve the objective functions within limits of some equality and inequality constraints which are filter parameters, quality factor, bus voltage magnitude, harmonic distortion for voltage and current, power balance and power factor limits. Five single objective functions are used to suppress harmonics in this case that are minimizing filter cost, voltage harmonic distortion "VHD", power losses, current harmonic distortion "CHD" and correcting power factor. Two optimization techniques are used for finding the best location of the STPFs and their optimal parameters, giving a global benefit to the system while also increasing its power quality. The suggested approaches are simulated utilizing IEEE 33-bus radial distribution test feeders. Then these two techniques are used to find the optimal location and the optimal parameters of a real system in Tala city.

This work is subdivided into six sections, one of which being this introductory. In the second, the designing and modelling of the proposed optimal shunt STPF are discussed. Description of problem formulation is presented in the third. In the fourth, the cases studied and results are subjected, while the last one presents the conclusion.

This template, created in MS Word 2007, provides authors with most of the formatting specifications needed for preparing electronic versions of their papers. All standard paper components have been specified for three reasons: 1) ease of use when formatting individual papers, 2) automatic compliance to electronic requirements that facilitate the concurrent or later production of electronic products, and 3) conformity of style throughout a journal paper. Margins, column widths, line spacing, and type styles are built-in; examples of the type styles are provided throughout this document and are identified in italic type, within parentheses, following the example. Some components, such as multi-leveled equations, graphics, and tables are not prescribed, although the various table text styles are provided. The formatter will need to create these components, incorporating the applicable criteria that follow.

## 2. Designing and Modeling of Proposed Optimal Shunt Single Tuned Passive Filter

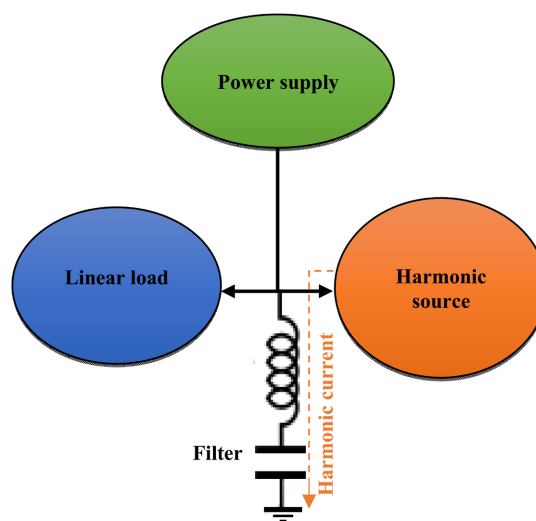
In power systems, passive filters are employed to decrease harmonic currents and minimize voltage distortion in sensitive network parts [22]. Harmonic filters are the most typical approach for preventing undesirable harmonic currents from flowing back into the power system by diverting them through a low impedance shunt circuit, with only a small fraction of the current flowing back into the system. **Figure 1** depicts the filter's basic principle [23]. While a harmonic source (such as a nonlinear load, distributed generation, renewable energy source, or power electronic device) injects harmonic currents into the power grid, the filter helps to absorb the current flow at a tuned resonance frequency, reducing harmonic transmission and, as a result, system harmonic distortion [24].

When a filter is connected in shunt, it only transmits the tuned harmonic current plus a lower overall fundamental current than the main network. In an alternating current power system, power converters are the direct source of harmonic currents. The ordering of the AC harmonic frequencies will be in the q-pulses after assessing the 6 and 12 pulse converters. The resonance frequency is the frequency at which the circuit will be in a resonance state, and it is commonly characterized in terms of harmonic order as the parameters listed below in Equations (1) and (2) [25]:

$$X_{l_{fil}} = X_{c_{fil}} \quad (1)$$

$$\omega_n l_{fil} = 1/\omega_n c_{fil} \quad (2)$$

where  $X_{l_{fil}}$  and  $X_{c_{fil}}$  are the filter inductive and capacitive reactance respectively,  $\omega_n$  denotes the resonant frequency of the suggested filter,  $l_{fil}$  and  $c_{fil}$  are suggested filter resonant inductance and capacitance,  $n$  is the resonant frequency number.



**Figure 1.** Basic principle of harmonic mitigation.

The resonance parameters must be lower than the filter parameters. To accomplish the desired performance of the optimal filter, the resistance, inductors, and capacitor values must be designed to function at a certain harmonic frequency while minimizing the associated harmonic distortion. STPF is used in a circuit to eliminate harmonic distortion by generating a resonant frequency that is lower than the harmonic frequency to be removed. The filter circuit in the STPF is suppressed at the desired harmonic frequency, resulting in a very low impedance and connecting the harmonic current to ground, preventing it from entering into the network [26]. Shunt filters may be constructed to meet any rating need.

### 3. Description of Problem Formulation

#### 3.1. The Variables Vector

It is expected in this study that a certain number of filters are placed in the electricity system. As a result, it must be chosen, where to allocate them, with the suggested technique including determining their parameters. Their allocations are determined by a vector  $ALL$ , which contains integer numbers, as presented in Equation (3):

$$ALL = [all_1, all_2, all_3, \dots, all_N] \quad (3)$$

where,  $N$  is the total number of filters to be assigned and  $all_N$  is the bus number where the  $N^{\text{th}}$  filter will be placed. As a result, the number of integer items in this vector is the same as the number of filters. The vector  $PAR$  will be used to inform the capacitance parameters of the filters as in Equation (4):

$$PAR = [c_1, c_2, c_3, \dots, c_N] \quad (4)$$

where,  $c_N$  is the capacitance value of the  $N^{\text{th}}$  filters. The tuned frequencies associated to each filter ( $f_N$ ) are informed by the vector  $fil$ , as in Equation (5):

$$fil = [f_1, f_2, f_3, \dots, f_N] \quad (5)$$

Finally, the quality factors of the filters ( $q_N$ ) are informed by the vector  $q$ , as in Equation (6):

$$q = [q_1, q_2, q_3, \dots, q_N] \quad (6)$$

Equations (7) and (8) should be used to calculate the inductance and resistance of single tuned filters based on capacitance values, tuned frequency, and quality factor.

$$f_N = 1 / (2\pi\sqrt{L_N c_N}) \quad (7)$$

$$q_N = \sqrt{L_N / c_N} / R_N \quad (8)$$

The solution is determined by the vector  $Vec$ , containing all the variables in  $ALL$ ,  $PAR$ ,  $fil$  and  $q$  as presented in Equation (9):

$$Vec = [ALL, PAR, fil, q] \quad (9)$$

### 3.2. Proposed Optimization Problem Formulation

The goal of this work is to enhance power quality by including the best STPF, which is based on decreasing the proposed filter cost “ $F1$ ,” power losses “ $F2$ ,” VHD “ $F3$ ,” and CHD “ $F4$ ”. All of the preview functions are combined into a single function, which will then be used as a multipurpose objective function to choose the optimal filter values and location within certain limitations.

#### 3.2.1. Minimizing the Proposed Filter Cost “ $F1$ ”

The greatest challenge of filter design is to minimize the total cost of the filter parameter. The most expensive parameter of any filter is the capacitor [27]. The total proposed filter costs objective function can be explained by [28]:

$$F1 = \text{Min Cost}_{\text{filt}} = \text{Min} \left[ B_1 R + B_2 X_{l_{\text{fil}}} + B_3 X_{c_{\text{fil}}} \right] \quad (10)$$

$$B_1 = 18185.161 \times 10^3 \left[ i_1^2 + \sum_{l=2}^h i_l^2 \right] \quad (11)$$

$$B_2 = 7274067.603 \left[ i_1^2 + \sum_{l=2}^h i_l^2 / l \right] \quad (12)$$

$$B_3 = 7274067.603 \left[ i_1^2 + \sum_{l=2}^h l \times i_l^2 \right] \quad (13)$$

#### 3.2.2. Minimizing Power Losses “ $F2$ ”

The real power losses at a network’s fundamental frequency are computed using standard fundamental power flow and are stated as follows [29]:

$$F2 = \text{Min } P_{\text{Losses}} = \text{Min} \sum_{l=1}^h \sum_{i=1}^{N_b} i_i^2 R_i \quad (14)$$

where,  $N_b$  is the number of network branches,  $P_{\text{Losses}}$  is the active power loss.

#### 3.2.3. Minimizing VHD “ $F3$ ”

When considering voltage harmonics, two significant variables,  $THD_v$  and  $IHD_v$ , must be included in the objective function. To decrease voltage harmonic distortion of the system, the following equation should be used [30]:

$$\text{Min “}THD_v\text{”} = \text{Min} \left( (1/|v_{i1}|) \sqrt{\sum_{h_n=2}^h |v_{h_n i}|^2} \right) \quad (15)$$

$$\text{Min “}IHD_v\text{”} = \text{Min} \left[ v_{h_n i} / |v_{i1}| \right] \quad (16)$$

where,  $v_{i1}$  is the fundamental bus voltage,  $h_n$  is the harmonic order,  $v_{h_n i}$  is the harmonic order voltage at bus  $i$ .

#### 3.2.4. Minimizing CHD “ $F4$ ”

As considering current harmonics, two major issues including  $THD_i$  and  $IHD_i$ , must be added in the objective function. To minimize the current harmonic distortion of the system, the following equations should be used [31]:

$$\text{Min “}THD_i\text{”} = \text{Min} \left( (1/|i_{i1}|) \sqrt{\sum_{h_n=2}^h |i_{h_n i}|^2} \right) \quad (17)$$

$$\text{Min “}IHD_i\text{”} = \text{Min} \left[ i_{h_n i} / |i_{i1}| \right] \quad (18)$$

where,  $i_{i1}$  is the fundamental bus current,  $h_n$  is the harmonic order,  $i_{h_n i}$  is

the harmonic order current at bus  $i$ .

### 3.2.5. Power Factor Correction "F5"

The goal of power factor correction (PFC) is to increase power factor and hence power quality. It lowers the burden on the electrical distribution system, improves energy efficiency, and lowers power costs. It also reduces the chance of device instability and failure. Harmonic filters can also generate a considerable amount of reactive power for power factor correction. To improve power factor of the distribution grid the following equation can be used [32]:

$$\text{Max } PF = \text{Max}[P/S] \quad (19)$$

where,  $P$  is the active power "W",  $S$  is the apparent power "VA".

### 3.2.6. Multi-Objective Function "F"

Finally, the Multi-objective function of the problem under consideration is introduced as follow:

$$F = a_1 F1 + a_2 F2 + a_3 F3 + a_4 F4 + a_5 F5^{-1} \quad (20)$$

In this research, a weighted technique is used to determine the objective function value of each recommended solution to a problem. As a result, the four factors  $a_1$ ,  $a_2$ ,  $a_3$  and  $a_4$ , are constrained by

$$a_1 + a_2 + a_3 + a_4 + a_5 = 1 \quad \text{and} \quad 0 \leq a_1, a_2, a_3, a_4, a_5 \leq 1. \quad (21)$$

## 3.3. Problem Constraints

The previews objective functions will be solved under the following constrains.

### 3.3.1. Power Balance Constraints

$$\sum_{i=1}^{n_g} P_{g_i} = \sum_{i=1}^{n_{load}} P_{load_i} + \sum_{i=1}^{n_{loss}} P_{loss_i} \quad (22)$$

$$\sum_{i=1}^{n_g} Q_{g_i} = \sum_{i=1}^{n_{load}} Q_{load_i} + \sum_{i=1}^{n_{loss}} Q_{loss_i} \quad (23)$$

### 3.3.2. Filter Parameter Limits

$$X_l^{\min} \leq X_{l_{fil}} \leq X_l^{\max} \quad (24)$$

$$X_c^{\min} \leq X_{c_{fil}} \leq X_c^{\max} \quad (25)$$

$$R^{\min} \leq R_{fil} \leq R^{\max} \quad (26)$$

where,  $X_l^{\min}$ ,  $X_l^{\max}$ ,  $X_c^{\min}$ ,  $X_c^{\max}$ ,  $R^{\min}$ , and  $R^{\max}$  are the limits of inductive reactance, capacitive reactance, and impedance respectively.

### 3.3.3. Quality Factor Constrains

$$Q_{factor}^{\min} \leq Q_{factor} \leq Q_{factor}^{\max} \quad (27)$$

where,  $Q_{factor}^{\min}$  and  $Q_{factor}^{\max}$  are the limits of power quality factor.

### 3.3.4. Voltage Limitations in All Network Buses

$$V_{\min} \leq V_i \leq V_{\max} \quad (28)$$

where,  $V_{\min}$  and  $V_{\max}$  are the voltage limits from 0.95 Pu to 1.05 Pu, respectively.

### 3.3.5. Harmonic Distortion Limits

By IEEE Std. 519,  $THD_v$ , and  $IHD_v$  should not be exceeded 5% and 3%,  $THD_i$  and  $IHD_i$  should not exceed 4% and 5%, respectively.

$$THD_v \leq THD_{v_{\max}} \quad (29)$$

$$IHD_v \leq IHD_{v_{\max}} \quad (30)$$

$$THD_i \leq THD_{i_{\max}} \quad (31)$$

$$IHD_i \leq IHD_{i_{\max}} \quad (32)$$

where,  $THD_{v_{\max}}$ ,  $IHD_{v_{\max}}$ ,  $THD_{i_{\max}}$  and  $IHD_{i_{\max}}$  are the maximum limits of  $THD_v$ ,  $IHD_v$ ,  $THD_i$  and  $IHD_i$ , respectively.

The presented objective functions will be evaluated by two new optimization techniques AOA and JFOT under the IEEE Std.519 restrictions and recommended standards.

## 3.4. Optimization Techniques

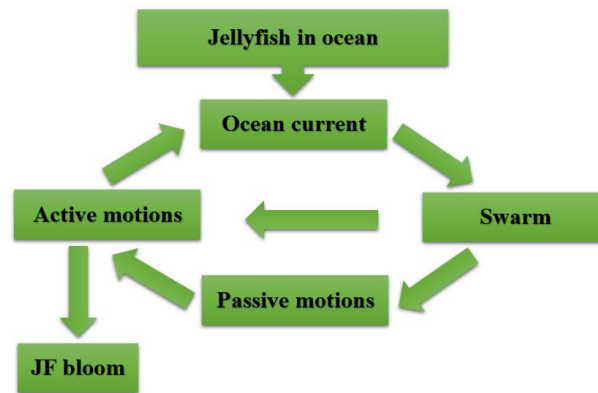
Because of the major importance of incorporating a STPF into distribution systems, different approaches are used for managing optimization issues while taking into consideration the various objective functions and all distribution power network constraints are created. A single tuned filter is used in this study to reduce the presence of harmonics in a radial distribution system with a high number of nonlinear loads. By installing and establishing the optimal placement as well as the excellent dimensional of single tuned filter units, a significant electric components are used in decreasing total power loss, improving the voltage profile, and keeping voltage and current harmonic distortion within an acceptable range. Algorithms for optimization various approaches, such as JFOT and AOA, attempt to find the optimum solution to a given optimization problem by lowering or increasing a defined objective fitness function which will be explained in this section.

### 3.4.1. Jellyfish Optimization Technique

The JFOT is one of the most modern optimization strategies, and is used to solve both single-objective and multi-objective optimization problems. This strategy, along with each Jellyfish's natural movements within the swarm and the subsequent ocean circulation to form Jellyfish blooms, has allowed these species to act almost everywhere in the ocean. Jellyfish visits some places where the amount of food changes; hence, the ideal site is discovered when food quantities are compared [33]. **Figure 2** depicts the Jellyfish algorithm's stages.

The first population of jellyfish swarm is formed according to Equation (33), then Jellyfish move around their location and this update will be formed according to Equation (34) [34]:





**Figure 2.** Jellyfish activity in the water.

$$M_k(t) = M_{\min} + \text{rand}(M_{\max} - M_{\min}), k = 1, \dots, N^{\text{pop}} \quad (33)$$

$$M_k(t+1) = M_k(t) + \gamma \cdot \text{rand}(0.1) \cdot (M_{\max} - M_{\min}) \quad (34)$$

where,  $M_{\max}$  and  $M_{\min}$  are the bounds of all decision variables in each considered solution;  $\gamma > 0$  is a motion coefficient that is proportional to the length of motion around the Jellyfish's sites [35]. So, this whole calculation process while using the Jellyfish optimization technique to estimate the placement and size of all installed STPF units in the distribution power network is illustrated and described in detail in **Figure 2**. The flowchart describes the calculation process steps as shown in **Figure 3**.

### 3.4.2. Arithmetic Optimization Algorithm

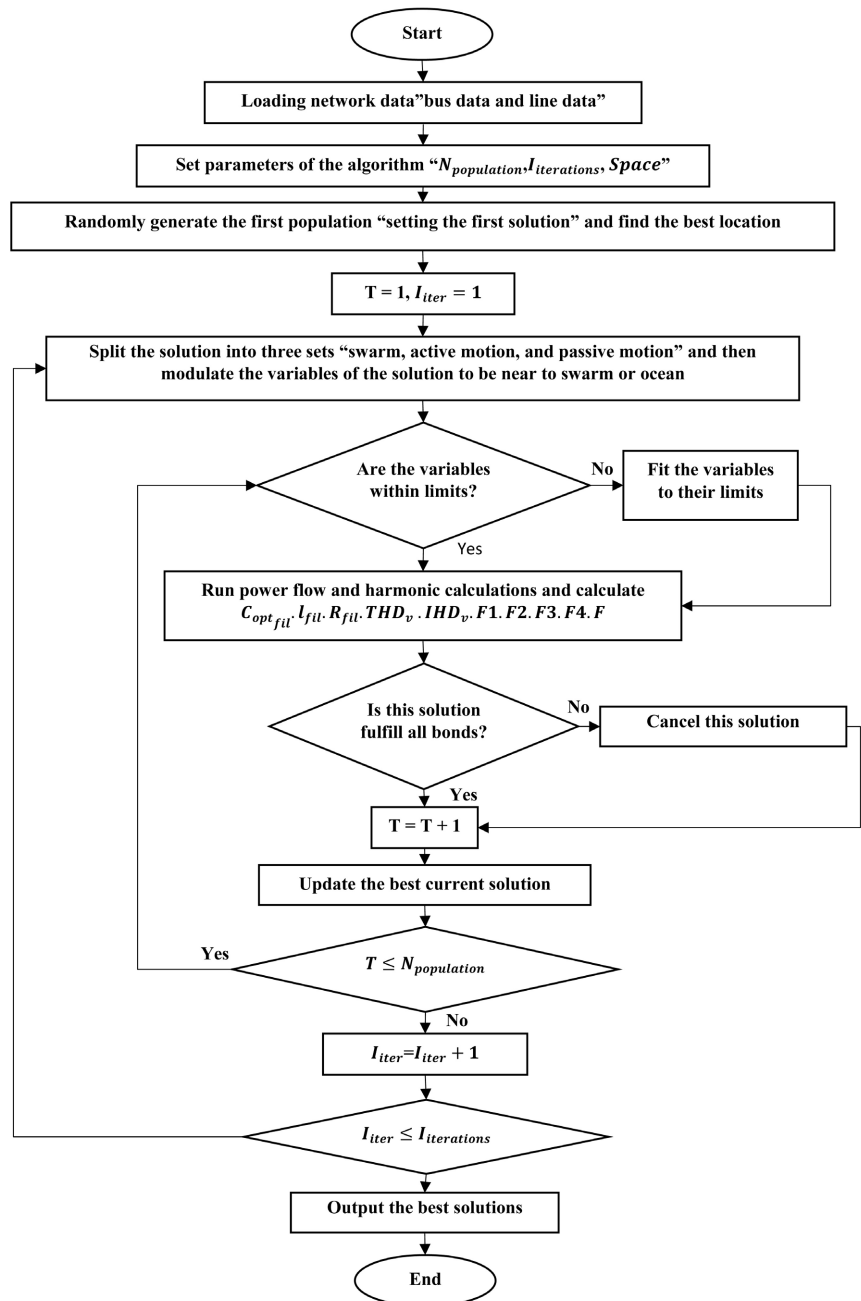
The proposed AOA's exploration (diversification) and exploitation (intensification) mechanisms are represented in the following sub-section, which are achieved by the Arithmetic operators in math *i.e.*:

- Multiplication (Mul “×”);
- Division (Div “÷”);
- Subtraction (Sub “−”);
- Addition (Add “+”).

This algorithm is a population-based meta-heuristic that solves optimization problems without the need to calculate their derivatives.

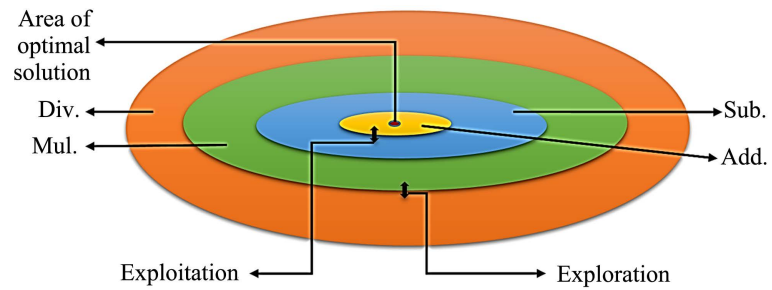
Arithmetic, along with geometry, algebra, and analysis, are a fundamental component of number theory and one of the most significant components of modern mathematics. The classic calculation methods used to examine numbers are arithmetic operators (*i.e.*, multiplication, division, subtraction, and addition). These basic operators are employed as a mathematical optimization to select the best element from a pool of potential alternatives based on particular criteria (solutions).

Optimization issues may be found in a wide range of quantitative fields, including engineering, economics, and computer science, as well as operations research and industry. The development of better solution approaches has piqued the attention of mathematicians for centuries. The usage of Arithmetic operators



**Figure 3.** Flowchart of Jellyfish technique for determining the parameters and location of STF.

in solving Arithmetic issues is the major source of inspiration for the proposed AOA. The behavior of Arithmetic operators and their impact on the proposed algorithm will be described in the following subsections. The hierarchy of Arithmetic operators and their dominance from the outside to the inside is depicted in **Figure 4**. The mathematical model is then used to suggest AOA. The optimization process in AOA starts with a collection of randomly generated candidate solutions (X), and the best candidate solution in each iteration is chosen the best-obtained solution or approaching the optimum so far. The AOA



**Figure 4.** AOA operation and its dominance from the outside to the inside.

should choose the search phase before it begins functioning (*i.e.*, exploration or exploitation). As a result, the Math Optimizer Accelerated (*MOA*) function is a coefficient generated using Equation (36) and employed in the subsequent search phases.

$$MOA(t) = M_{\min} + \left[ t \cdot \left( \frac{M_{\max} - M_{\min}}{t_{\max}} \right) \right] \quad (35)$$

According to Arithmetic operators, mathematical operations are utilizing either the Division (Div.) or Multiplication (Mul.) operators resulted in highly scattered values or choices that commit to the exploratory search process. However, unlike other operators (Sub and Add), these operators (Div. and Mul.) cannot easily approach the objective due to their great dispersion. To use this algorithm as a method for determining the optimal allocation of the single tuned passive filter for any network. The flowchart describes the calculation process steps as shown in **Figure 5**.

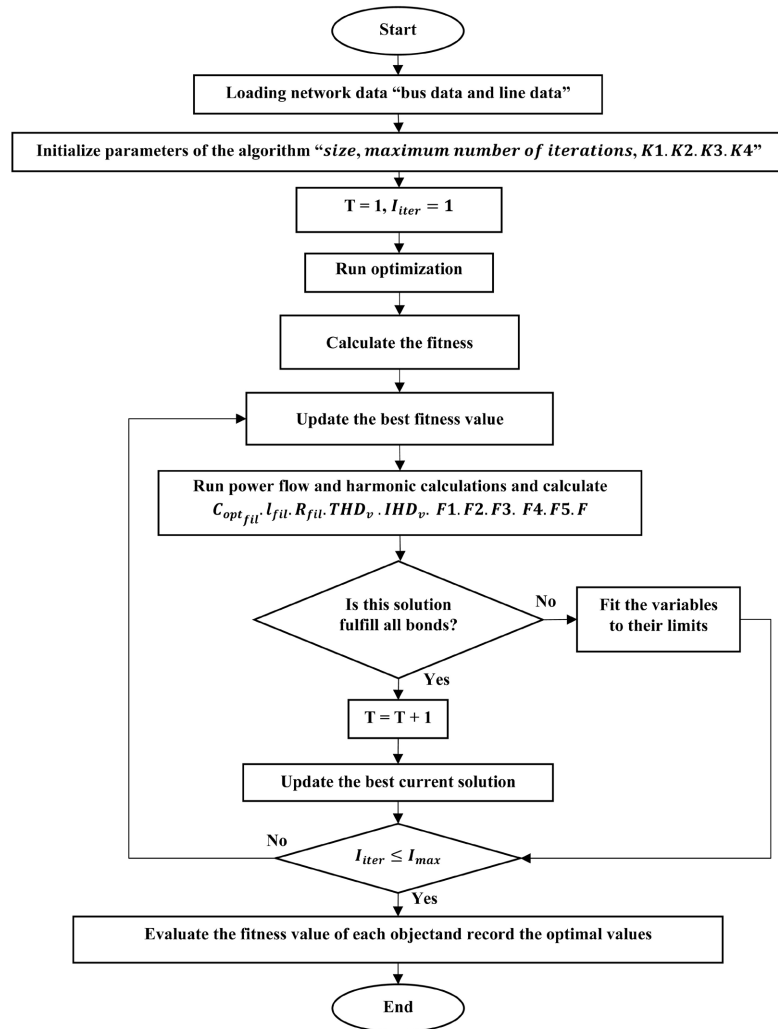
## 4. Studied Cases and Results

### 4.1. System Description

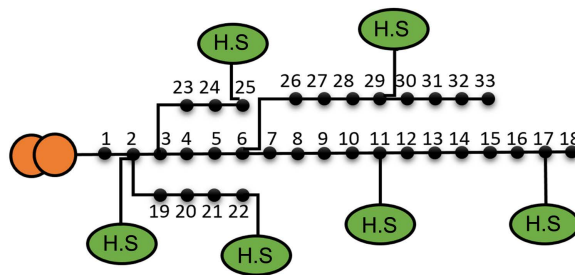
#### 4.1.1. Stander System “IEEE 33-Bus System”

The target functions are applied to the IEEE 33-bus distribution power network to meet the IEEE Std. 519 standards of keeping all buses' voltages within acceptable bounds. The system's data is obtained from [36]. In this part, five harmonic sources “HS” concurrently are injected to six loads situated at buses 2, 11, 17, 22, 25, and 29, as illustrated in **Figure 6**. **Table 1** presents an analysis of the magnitude and angle of the five harmonic source flows, such as order, magnitude, and angle that are taken from [37].

As explained previously in [38], a filter was designed for the same distribution electrical network using JFOT. Currently, a filter will be designed using AOA for the five objective functions under the different constrains. Of course, injecting the five harmonic on the distribution system had a negative effect in the character of both voltage and current waves at all buses. Many optimal filters are now constructed and given in the following part to improve the power quality at all networks. Each of these filters may be connected individually at the best place to improve power quality and restrict voltage and current. The jellyfish optimization approach and AOA are implemented in MATLAB programmer using m-file code and the iteration number is 50.



**Figure 5.** Flowchart of AOA algorithm for determining the parameters and location of STF.



**Figure 6.** IEEE 33-bus distribution network injected with six harmonic sources.

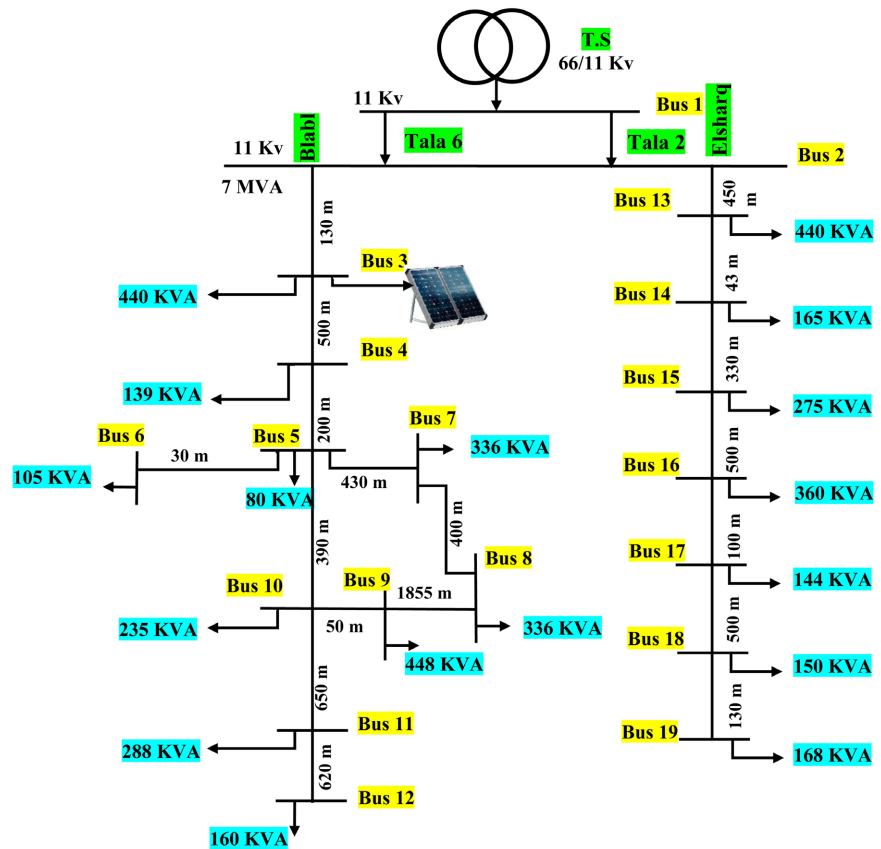
**Table 1.** Harmonic analysis of five harmonic sources injected from loads in power distribution system

Harmonic order	5	7	11	13	17
Magnitude	0.766	0.63	0.25	0.0128	0.073
Angle	28.5	-178	-61.5	82	-255

### 4.1.2. Real System “Tala City”

These two optimization approaches are used to find the optimal filters in a real system at Tala network. The distribution system of Tala city is shown in **Figure 7**.

This system is consists of two main feeders “Blabl feeder and Elsharq feeder” with 19 secondary buses loaded with various loads. At the bus 3, there is a 12.5 kW solar plant with power 12.5 kW as shown in **Figure 8**. It is consists of 40 module direct online to the network. The modules data are shown in **Table 2**.



**Figure 7.** Single line diagram of Tala city distribution network.

**Table 2.** Data of 310 w solar module.

Product PS M72H-310 W	
Maximum power “w”	310 ± 3%
Open circuit voltage “v”	45.6
Short circuit current “A”	9.05
Voltage at maximum power “v”	36.3
Current at maximum power “A”	8.54
Maximum system voltage “v”	1000
Maximum reverse current “A”	15
Operating Temperature	-40: +85°C



**Figure 8.** Solar plant connected at Tala distribution system at bus 3.

## 4.2. Results

### 4.2.1. Results of IEEE-33 Bus System

Applying the two algorithms to the IEEE-33 bus system, the results are shown in **Table 3**. The table shows the results of the each single objective function using the two algorithms. Also, the results of multi-objective function by using the two algorithms are presented. These results prove that using the multi-objective function is the optimal answer. The JFOT program locates three filters at buss 2, 12 and 23, but AOA program locates the three filters at buss 2, 6 and 25.

From the results, AOA can achieve the problem constraints and give better results than JFOT. In both techniques “AOA and JFOT”, the problem constrains are achieved, but AOA is better in reducing the power losses and the filter price. **Figure 9** and **Figure 10** show the current and voltage spectrum at bus 1 with HS before filter and after filter using the two algorithms, respectively. **Figure 11** shows the voltage at each bus before and after allocating the filters. **Figure 12** shows the power factor correction that is achieved after allocating the filters compared with the power factor before allocating the filters.

Comparing these results with results in [38], it will be found that the AOA gives the more accurate results. In [38], the filter cost was more expensive than in case of using AOA technique by 7.44%. Also, the power losses decreased by 6.5% in this paper than [38]. The maximum voltage and current total harmonic distortion decreased in this paper than [38] by 1% and 5% respectively. Moreover, the maximum voltage and current individual harmonic distortion decreased in this paper than [38] by 2.1% and 1.95% respectively. The filter locations have also been changed using the new algorithm and the new location are near to the harmonic sources and this helps in preventing the harmonics to obtrusion the network and affect it.

**Table 3.** Optimal filter parameters and filter cost after applying JFOT and AOA algorithms at IEEE-33 bus system.

Results of IEEE-33 bus system	Without filter	With filter													
		MOF			SOF										
		F	F1	F2	F3	F4	F5								
$Cost_{filt}$ "\$"	-	JFOT	1st	2015.4	1852.4	2136.3	2369.5	2256.4	2678.2						
			2nd	1468.6	5249.5	1485.6	4873.8	1869.5	5969.3	1854.2	6009	1947.1	5959.8	1956.3	6430.1
			3rd	1765.8	1535.8	1963.5	1785.3	1756.3	1795.6						
		AOA	1st	2012.5	1826.1	2102.3	2332.4	2213.6	2650.1						
			2nd	1452.3	4886.1	1475.6	4802.9	1815.6	5866.4	1831.6	5923.8	1914.7	5854.8	1941.5	6347.8
			3rd	1421.3	1501.2	1948.5	1759.8	1726.5	1756.2						
$Max THD_v$ %	9.033	JFOT	2.225	2.325	2.425	2.2	2.565	2.46							
		AOA	2.202	2.31	2.401	2.07	2.46	2.4							
$Max IHD_v$ %	3.9135	JFOT	1.564	1.64	1.658	1.5	1.598	1.54							
		AOA	1.532	1.602	1.614	1.24	1.57	1.49							
$Max THD_i$ %	23.5	JFOT	1.95	1.195	1.96	1.2	1.103	1.85							
		AOA	1.86	1.1	1.75	1.13	1.08	1.74							
$Max IHD_i$ %	7.62	JFOT	1.417	1.218	1.58	1.04	1.01	1.39							
		AOA	1.39	1.14	1.45	0.98	0.97	1.24							
$P_{loss}$ "MW"	0.02037	JFOT	0.0197	0.01995	0.0104	0.01954	0.01923	0.0198							
		AOA	0.0185	0.019	0.01	0.018	0.018	0.0187							
$R_{fil}$ "\$\Omega\$"	-	JFOT	1st	0.0256	0.0198	0.0145	0.0369	0.0345	0.0358						
			2nd	0.0165	0.0147	0.1258	0.1698	0.1674	0.1658						
			3rd	0.0033	0.0025	0.0014	0.0048	0.0078	0.0057						
		AOA	1st	0.0236	0.0178	0.0125	0.0349	0.0325	0.0338						
			2nd	0.01438	0.01258	0.12368	0.16768	0.16528	0.16368						
			3rd	0.0031	0.0023	0.0012	0.0046	0.0076	0.0055						
$I_{fil}$ "mH"	-	JFOT	1st	0.0125	0.0114	0.0105	0.0155	0.0189	0.0158						
			2nd	0.00965	0.00905	0.009	0.0145	0.0198	0.019						
			3rd	0.0106	0.0096	0.0087	0.0025	0.0046	0.0048						
		AOA	1st	0.0105	0.0094	0.0085	0.0135	0.0169	0.0138						
			2nd	0.00845	0.00785	0.0078	0.0133	0.0186	0.0178						
			3rd	0.0094	0.0084	0.0075	0.0013	0.0034	0.0036						
$C_{fil}$ "\$\mu F\$"	-	JFOT	1st	66.98	56.8	78.9	74.6	72.3	75.6						
			2nd	59.23	56.3	57.4	57.3	59.4	58.4						
			3rd	73.08	69.5	68.5	78.1	74.2	69.8						

Continued

		1st	65.66	55.48	77.58	73.28	70.98	74.28
	<b>AOA</b>	2nd	57.99	55.06	56.16	56.06	58.16	57.16
		3rd	71.52	67.94	66.94	76.54	72.64	68.24
<b>Q<sub>c</sub></b> "MVAR"	-	<b>JFOT</b>	2.86	3.69	3.91	3.65	3.94	3.98
	-	<b>AOA</b>	2.79	3.6	3.87	3.59	3.89	3.92
<b>Location of filters</b>	-	<b>JFOT</b>	3 filters located at Buss 2, 12, 23					
	-	<b>AOA</b>	3 filters located at Buss 2, 6, 25					

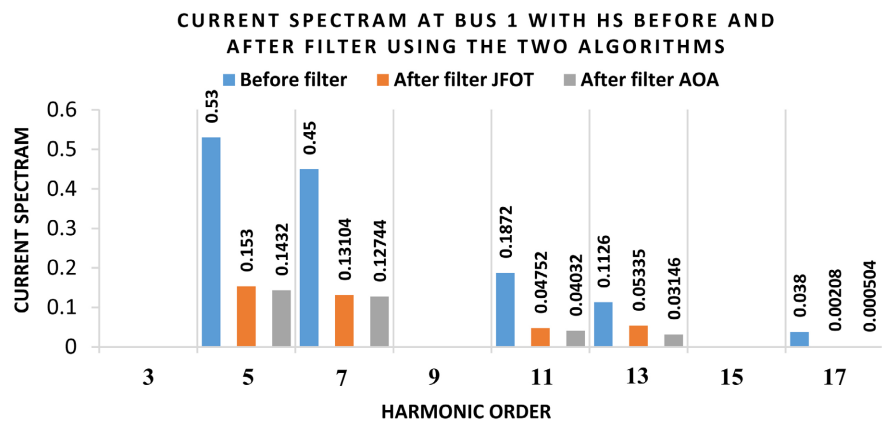


Figure 9. Current spectrum at bus 1 with HS before filter and after filter using two algorithms.

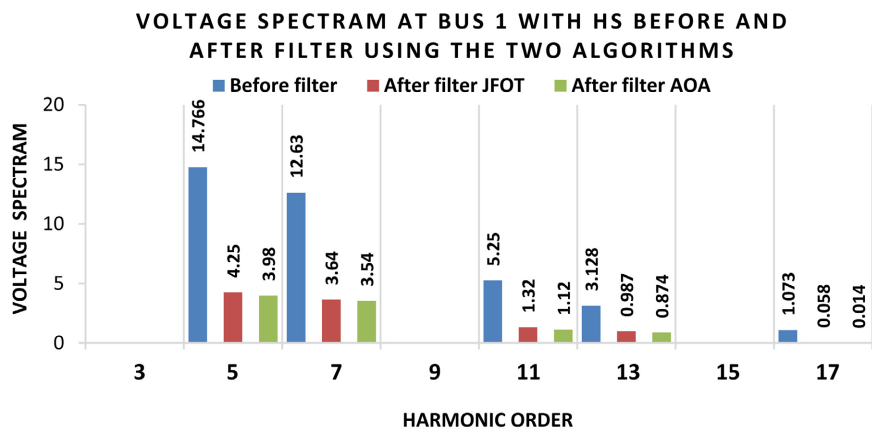
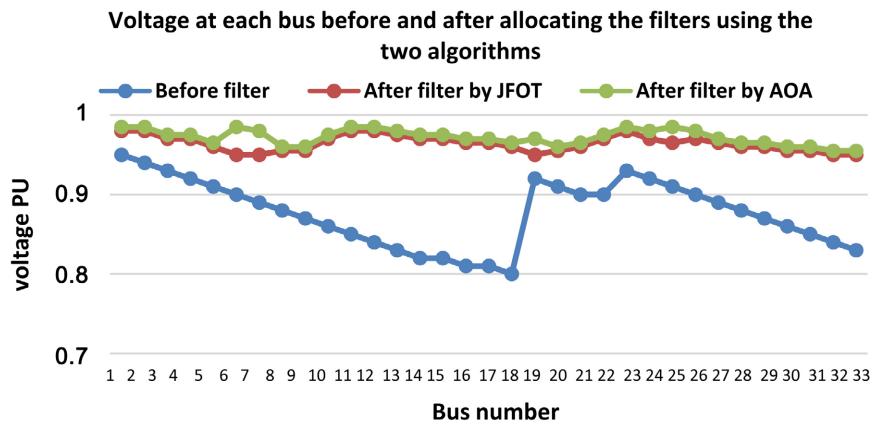


Figure 10. Voltage spectrum at bus 1 with HS before filter and after filter using two algorithms.

#### 4.2.2. Results of Real System at Tala City

Applying the two algorithms to the real system at Tala city, the results is shown in Table 4. This table shows the results of each single objective function alone using the two algorithms. Also, the results of multi-objective function by using the two algorithms is presented. The JFOT and AOA program locate three the filters at buss 2.



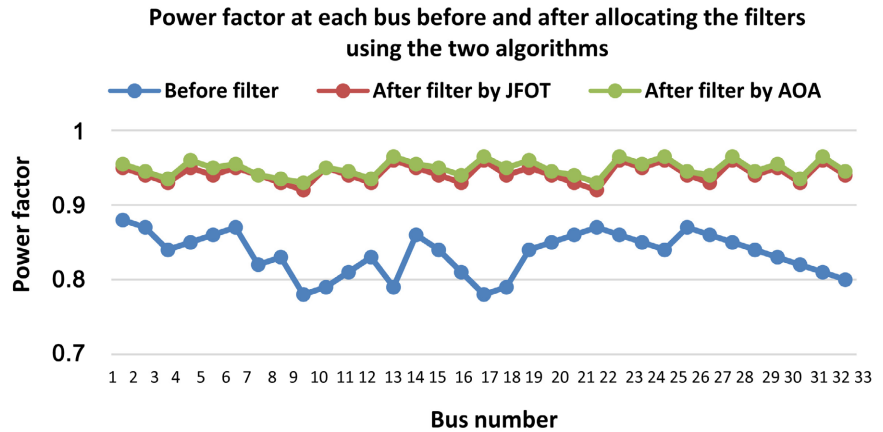


**Figure 11.** Voltage at each bus before and after allocating the filters using the two algorithms.

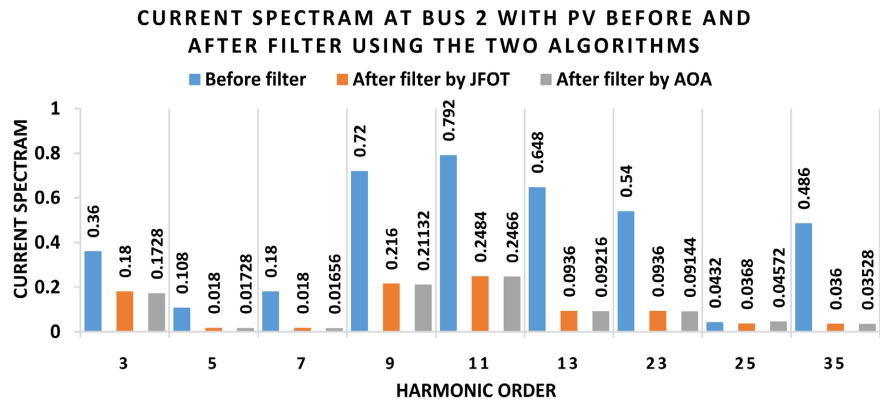
**Table 4.** Optimal filter parameters and filter cost after applying JFOT and AOA algorithms at Tala Sharq bus system.

Results of real system at Tala	Without filter	With filter						
		MOF	Single objective function					
			F	F1	F2	F3	F4	F5
$Cost_{filt}$ “\$”	-	JFOT	192.72	179.88	187.21	211.081	214.752	206.5
		AOA	189.46	167.35	181.14	208.63	212.96	198.2
$Max THD_v$ %	16.7	JFOT	2.9	3.85	3.1	2.5	3.6	3.6
		AOA	2.851	2.754	2.47	2.01	2.97	3.12
$Max IHD_v$ %	14.1	JFOT	2.75	3.6	2.95	2.15	3.45	3.5
		AOA	2.58	2.43	2.86	1.97	3.01	3.1
$Max THD_i$ %	22	JFOT	6.4	6.9	6.54	6.82	6.06	6.85
		AOA	6.35	6.89	6.48	6.74	6.86	6.2
$Max IHD_i$ %	18.4	JFOT	6.38	6.52	6.41	6.74	5.98	6.2
		AOA	6.15	6.47	6.25	6.51	5.9	5.95
$P_{loss}$ “kW”	147.5	JFOT	72.5	68.2	65.8	78.5	80.4	70.1
		AOA	71.2	70.1	66.4	73.4	76.5	69.7
$R_{fil}$ “Ω”	-	JFOT	0.0654	0.062	0.0601	0.0668	0.066	0.059
		AOA	0.0601	0.0598	0.053	0.059	0.0582	0.051
$l_{fil}$ “mH”	-	JFOT	0.0395	0.0301	0.035	0.041	0.045	0.0402
		AOA	0.0359	0.0345	0.06	0.067	0.0	.0398
$C_{fil}$ “μF”	-	JFOT	6.664	5.98	6.052	6.67	6.701	6.68
		AOA	6.651	5.82	6.027	6.42	6.69	6.15
$Q_c$ “MVAR”	-	JFOT	105	98	102	115	117	118
		AOA	102	95	99	110	113	101
Location of filters	-	JFOT	Fixed at bus 2					
		AOA						

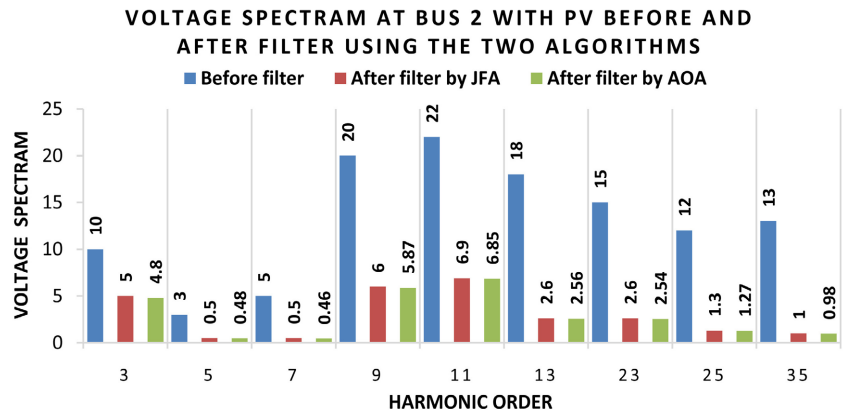
From these results, AOA can achieve the problem constraints and give better results than JFOT. In both techniques “AOA and JFOT”, the problem constraints are achieved, but AOA is better in reducing the power losses and the filter price. The two algorithms located the optimal filter at bus 2. **Figure 13** and **Figure 14** show the current and voltage spectrum at bus 2 before filter and after filter by



**Figure 12.** Power factor at each bus before and after allocating the filters using the two algorithms.

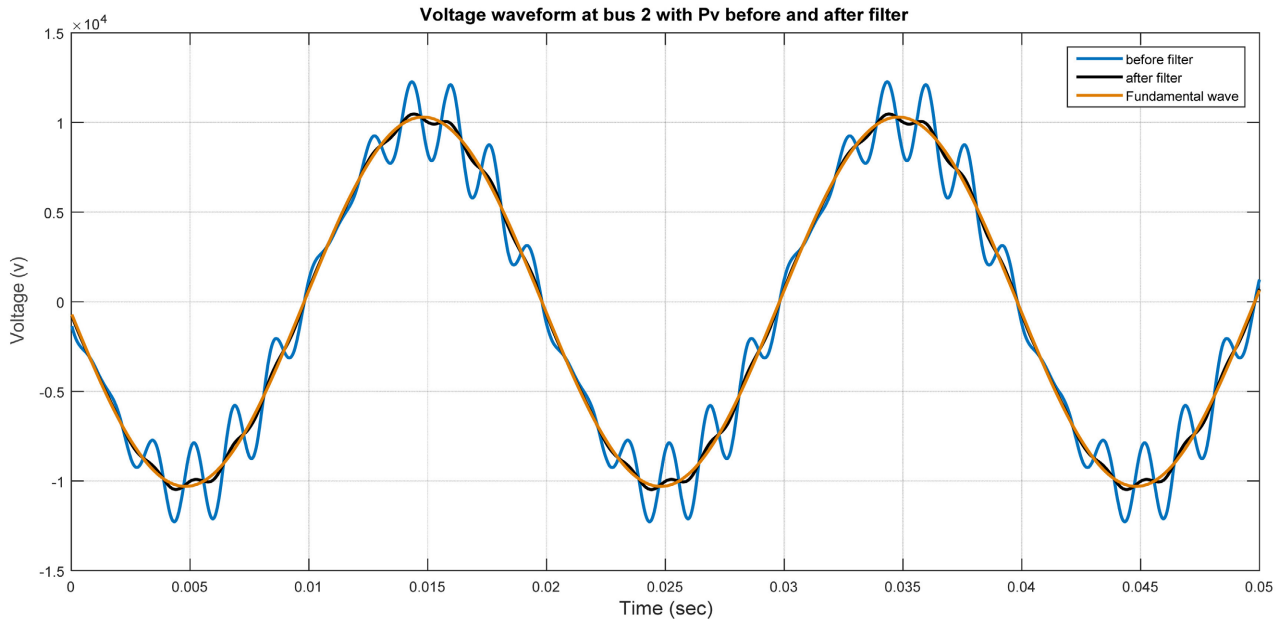


**Figure 13.** Current spectrum at bus 2 before filter and after filter using two algorithms.

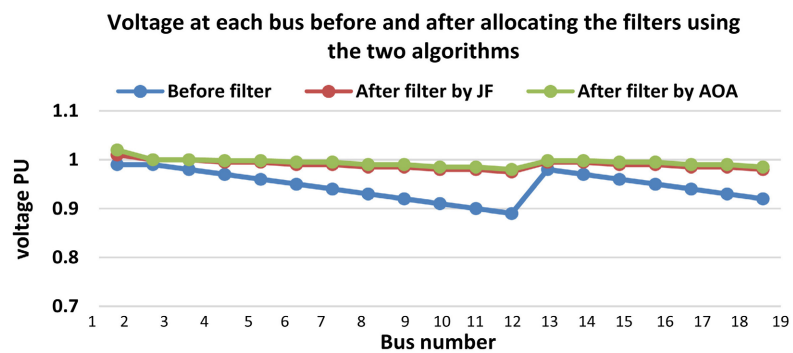


**Figure 14.** Voltage spectrum at bus 2 before filter and after filter using two algorithms.

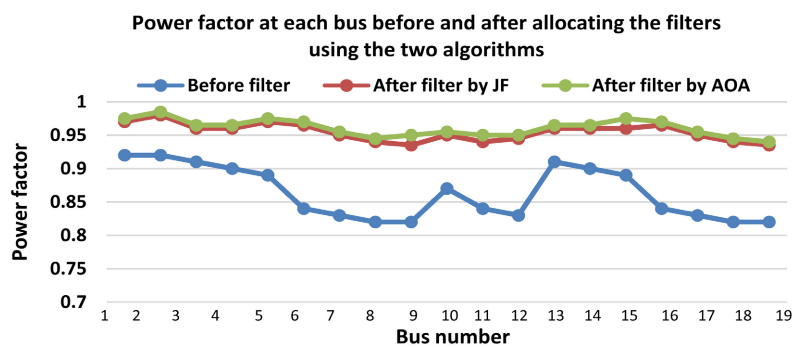
two algorithms, respectively. **Figure 15** shows the voltage waveform at bus 2 before and after allocating the filter. **Figure 16** shows the voltage at each bus before and after allocating the filter. **Figure 17** shows the power factor correction that



**Figure 15.** Voltage waveform at bus 2 before and after filter.



**Figure 16.** Voltage at each bus before and after allocating the filters using the two algorithms.



**Figure 17.** Power factor at each bus before and after allocating the filters by using the two algorithms.

is achieved after allocating the filter compared with the power factor before allocating the filter.

## 5. Conclusions

In this paper, based on power balance, filter characteristics, quality factor, voltage, and harmonic distortion standards, a STPF has been designed for a distribution system to reduce cost, actual power losses, THD, and IHD. These filters have been designed using two new algorithms, the JFOT and the AOA. The two techniques have been tested using the IEEE 33-bus system and a real system at Tala city. The results of the optimization techniques have provided the optimal filter values and their placement. The results show that AOA gives the best filter values than JFOT. The two techniques give the filter values that achieve the limits of IEEE standers. AOA gives optimal results compared with JFOT.

The next research will be applied to a realistic network with a filter inserted, applying the proposed type of filters to it and showing the extent of the difference between them and which one will improve the network.

## Conflicts of Interest

The authors declare no conflicts of interest regarding the publication of this paper.

## References

- [1] Sirjani, R. and Hassanpour, B. (2012) A New Ant Colony-Based Method for Optimal Capacitor Placement and Sizing in Distribution Systems. *Research Journal of Applied Science, Engineering and Technology*, **4**, 888-891.
- [2] Abdelrahman, S. and Milanović, J.V. (2019) Practical Approaches to Assessment of Harmonics along Radial Distribution Feeders. *IEEE Transactions on Power Delivery*, **34**, 1184-1192. <https://doi.org/10.1109/TPWRD.2019.2901245>
- [3] Kazemi-Robati, E. and Sepasian, M.S. (2019) Passive Harmonic Filter Planning Considering Daily Load Variations and Distribution System Reconfiguration. *Electric Power Systems Research*, **166**, 125-135. <https://doi.org/10.1016/j.epsr.2018.09.019>
- [4] Stanelyte, D. and Radziukynas, V. (2020) Review of Voltage and Reactive Power Control Algorithms in Electrical Distribution Networks. *Energies*, **13**, 58-84. <https://doi.org/10.3390/en13010058>
- [5] Abou El-Ela, A.A., Allam, S. and El-Arwash, H. (2008) An Optimal Design of Single Tuned Filter in Distribution Systems. *Electric Power Systems Research*, **78**, 967-974. <https://doi.org/10.1016/j.epsr.2007.07.004>
- [6] Feng, C., Gao, Z., Sun, Y. and Chen, P. (2021) Electric Railway Smart Microgrid System with Integration of Multiple Energy Systems and Power-Quality Improvement. *Electric Power Systems Research*, **199**, 107459-107472. <https://doi.org/10.1016/j.epsr.2021.107459>
- [7] Mahela, O.P. and Shaik, A.G. (2016) Topological Aspects of Power Quality Improvement Techniques: A Comprehensive Overview. *Renewable and Sustainable Energy*, **58**, 1129-1142. <https://doi.org/10.1016/j.rser.2015.12.251>
- [8] Prasad, D.D., Chandini, B.L. and Mahesh, S. (2021) Power Quality Improvement in

- WECS Using ANN—Statcom. *International Journal for Modern Trends in Science and Technology*, **7**, 160-165.
- [9] El Sayed, M.M., *et al.* (2018) Effect of Photovoltaic System on Power Quality in Electrical Distribution Networks. 2016 *Eighteenth International Middle East Power Systems Conference (MEPCON)*, Cairo, 27-29 December 2016, 1005-1012.
- [10] Mouheb, M., Malek, A. and Loukarfi, L. (2019) Contribution of Solar Energy for the Correction of the Voltage Drop Recorded on a LV Power Grid in Algeria. *Energy Sources*, **42**, 2485-2500. <https://doi.org/10.1080/15567036.2019.1607948>
- [11] Melo, I.D., *et al.* (2020) Allocation and Sizing of Single Tuned Passive Filters in Three-Phase Distribution Systems for Power Quality Improvement. *Electric Power Systems Research*, **180**, Article ID: 106128. <https://doi.org/10.1016/j.epsr.2019.106128>
- [12] Abdelbadie, H.T.K., Taha, A.T.M., Hasaniien, H.M., Turkey, R.A. and Muyeen, S.M. (2022) Stability Enhancement of Wind Energy Conversion Systems Based on Optimal Super Conducting Magnetic Energy Storage Systems Using the Archimedes Optimization Algorithm. *Processes*, **10**, Article 366. <https://doi.org/10.3390/pr10020366>
- [13] Hsiao, Y.-T. (2001) Design of Filters for Reducing Harmonic Distortion and Correcting Power Factor in Industrial Distribution Systems. *Tamkang Journal of Science and Engineering*, **4**, 193-199.
- [14] Zavoda, F., Bollen, M.H.J. and Moreno, A. (2018) Power Quality and EMC Issues with Future Electricity Networks. CIGRE, Paris, 26-54.
- [15] Yang, N.C. and Le, M.D. (2015) Optimal Design of Passive Power Filters Based on Multi-Objective Bat Algorithm and Pareto Front. *Applied Soft Computing*, **35**, 257-266. <https://doi.org/10.1016/j.asoc.2015.05.042>
- [16] Robati, E.K. and Sepasian, M.S. (2019) Passive Harmonic Filter Planning Considering Daily Load Variations and Distribution System Reconfiguration. *Electric Power Systems Research*, **166**, 125-135. <https://doi.org/10.1016/j.epsr.2018.09.019>
- [17] Zobaa, A.F. and Aleem, S. (2014) A New Approach for Harmonic Distortion Minimization in Power Systems Supplying Nonlinear Loads. *IEEE Transactions on Industrial Informatics*, **10**, 1401-1412. <https://doi.org/10.1109/TII.2014.2307196>
- [18] Carpinelli, G., Caramia, P., Russo, A. and Verde, P. (2004) Decision Theory Criteria for Sizing Cable and Harmonic Filters in Distribution Systems. *39th International Universities Power Engineering Conference*, Bristol, 6-8 September 2004, 44-48.
- [19] Abdel Aziz, M.M., Abou El-Zahab, E.E. and Abdel Salam, G.A. (2003) New Techniques of the Passive Filter Design in Industrial Applications: A Case Study. *9th International Middle-East Power Systems Conference, MEPCON'03*, Shebin-Elkom, 16-18 December 2003, 769-780.
- [20] Mahmoud, K., Hussein, M.M., Abdel-Nasser, M. and Lehtonen, M. (2020) Optimal Voltage Control in Distribution Systems with Intermittent PV Using Multiobjective Grey-Wolf-Lévy Optimizer. *IEEE Systems Journal*, **14**, 760-770. <https://doi.org/10.1109/JSYST.2019.2931829>
- [21] Hussain, M.W. and Qureshi, M.A. (2021) Analysis and Design of Passive Filters for Power Quality Improvement in 3 $\phi$  Grid-Tied PV Systems. *4th International Conference on Energy Conservation and Efficiency (ICECE)*, Lahore, 16-17 March 2021, 1-6.
- [22] Dadhich, A., Sharma, J., Kumawat, S. and Tandon, A. (2021) Power Quality Improvement in 3- $\Phi$  Power System with Shunt Active Filter Using Synchronous Detection Method. *International Journal of Electrical, Electronics and Computers*, **6**, 92-95. <https://doi.org/10.22161/eec.63.12>
- [23] Theraja, B.L. and Theraja, A.K. (2005) A Textbook of Electrical Technology: Basic

- Electrical Engineering in S.I. System of Units. S. Chand & Company Ltd., London.
- [24] Sanjeevikumar, P., Sharmeela, C., Holm-Nielson, B.J. and Sivaraman, P. (2021) Power Quality in Modern Systems. Elsevier Inc., Amsterdam.
- [25] Anaya-Lara, O. and Acha, E. (2002) Modeling and Analysis of Custom Power Systems. *IEEE Transactions on Power Delivery*, **17**, 266-272. <https://doi.org/10.1109/61.974217>
- [26] Shehata, S.A., Khalil, H.S. and Mena, S.K. (2000) Harmonic Analysis and Filter Design for the Underground Greater Cairo Metro. *MEPCON 2000*, Cairo, 28-30 March 2000, 32-40.
- [27] IEEE Power and Energy Society (2014) 519-2014—IEEE Recommended Practice and Requirements for Harmonic Control in Electric Power Systems.
- [28] Tamilselvan, V., Jayabarathi, T. and Raghunathan, T. (2018) Optimal Capacitor Placement in Radial Distribution Systems Using Flower Pollination Algorithm. *Alexandria Engineering Journal*, **57**, 2775-2786. <https://doi.org/10.1016/j.aej.2018.01.004>
- [29] Beleiu, H.G., Beleiu, I.N., Pavel, S.G. and Darab, C.P. (2018) Management of Power Quality Issues from an Economic Point of View. *Sustainability*, **10**, 2326-2342. <https://doi.org/10.3390/su10072326>
- [30] Abbas, S., El-Sehiemy, R.A., Abou El-Ela, A.A., Mahmoud, E.S., Lehtonen, K., Darwish, M., *et al.* (2021) Optimal Harmonic Mitigation in Distribution Systems with Inverter Based Distributed Generation. *Applied Sciences*, **11**, 774-790. <https://doi.org/10.3390/app11020774>
- [31] Diwan, S.P., Inamdar, H.P. and Vaidya, A.P. (2011) Simulation Studies of Shunt Passive Harmonic Filters: Six Pulse Rectifier Load Power Factor Improvement and Harmonic Control. *ACEEE International Journal on Electrical and Power Engineering*, **2**, 1-6.
- [32] Harmonic Spectrum (2021, January 20). <https://github.com/tshort/OpenDSS/blob/master/Test/indmachtest/Spectrum.DSS>
- [33] Chou, J.-S. and Truong, D.-N. (2020) A Novel Metaheuristic Optimizer Inspired by Behavior of Jellyfish in Ocean. *Applied Mathematics and Computation*, **389**, 125535-125582. <https://doi.org/10.1016/j.amc.2020.125535>
- [34] Alam, A., Verma, P., Tariq, M., Sarwar, A., Alamri, B., Zahra, N. and Urooj, S. (2021) Jellyfish Search Optimization Algorithm for MPP Tracking of PV System. *Sustainability*, **13**, Article No. 11736. <https://doi.org/10.3390/su132111736>
- [35] Chou, J.-S. and Truong, D.-N. (2020) Multiobjective Optimization Inspired by Behavior of Jellyfish for Solving Structural Design Problems. *Chaos, Solitons & Fractals*, **135**, Article ID: 109738. <https://doi.org/10.1016/j.chaos.2020.109738>
- [36] Sedighzadeh, M., Doyran, R.V. and Re, A. (2020) Optimal Simultaneous Allocation of Passive Filters and Distributed Generations as Well as Feeder Reconfiguration to Improve Power Quality and Reliability in Microgrids. *Journal of Cleaner Production*, **265**, 1016-1056. <https://doi.org/10.1016/j.jclepro.2020.121629>
- [37] Chavan, P.R. and Patil, B.R. (2022) Power Quality Improvement Techniques in Distribution Network with Harmonic Consideration. *Journal of Harbin Institute of Technology*, **54**, 276-283.
- [38] El-Ela, A.A., Allam, S.M., El-Sehiemy, R.A. and Mubarak, A. (2021) Optimal Location and Size of Tuned Passive Filter Using Jelly Fish Algorithm. 2021 *22nd International Middle East Power Systems Conference (MEPCON 2021)*, Assiut, 14-16 December 2021, 683-689.